

# backward compatibility of LM Math

Is

backward compatibility of LM Math  
and CM math sensible?

Piotr Strzelczyk

Our goal was to prepare new versions of the well known (and widely used) fonts: Computer Modern (*by Donald E. Knuth*).

Our goal was to prepare new versions of the well known (and widely used) fonts: Computer Modern (*by Donald E. Knuth*).

We wanted to achieve compatibility of the new Latin Modern OTF math font with the CM original fonts

Our goal was to prepare new versions of the well known (and widely used) fonts: Computer Modern (*by Donald E. Knuth*).

We wanted to achieve compatibility of the new Latin Modern OTF math font with the CM original fonts, at least we wanted to keep the widths of METAFONT prototype.

Easy?

# Easy?

Like you might expect,  
it's rather hard because of...

# Easy?

Like you might expect,  
it's rather hard because of...  
some strange decisions by Knuth  
(not bugs of course :)





# Strange decisions

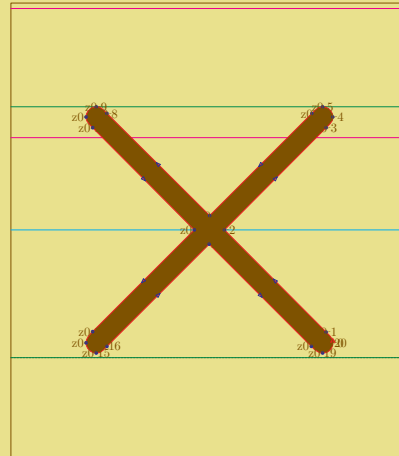
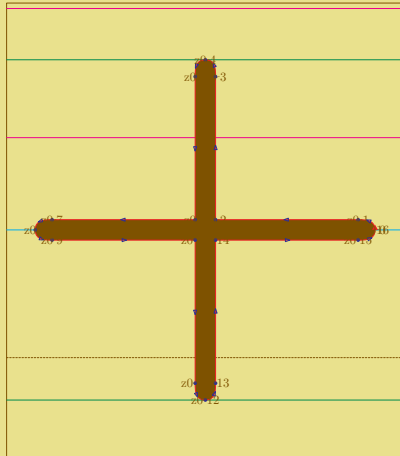

The character `\times` has the width of plus `+` which makes the sidebearings of `×` bigger.



# Strange decisions

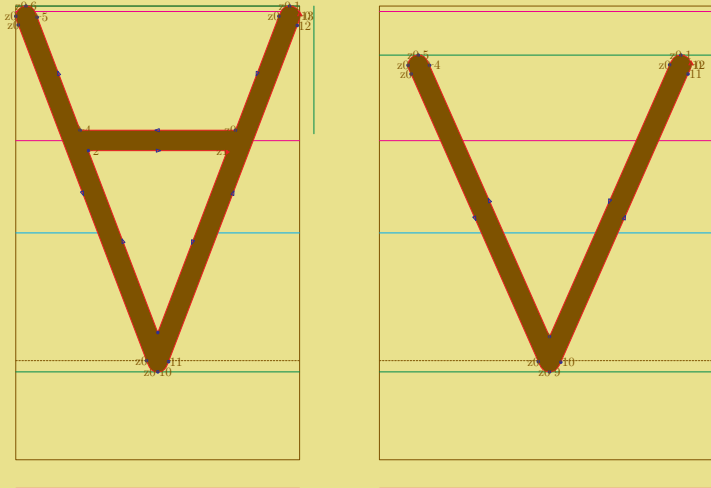

$\forall$  (`\forall`) has no sidebearings  
but  $\forall$  and  $\exists$  have normal margins.

# Strange decisions

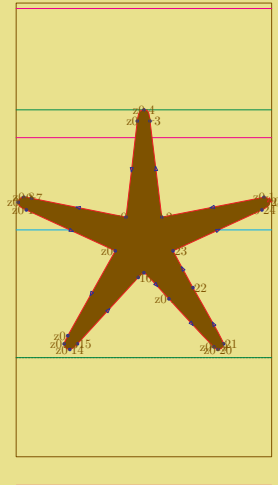

`\star` also has no sidebearings  
(and who needs such a big star?)

## Strange decisions

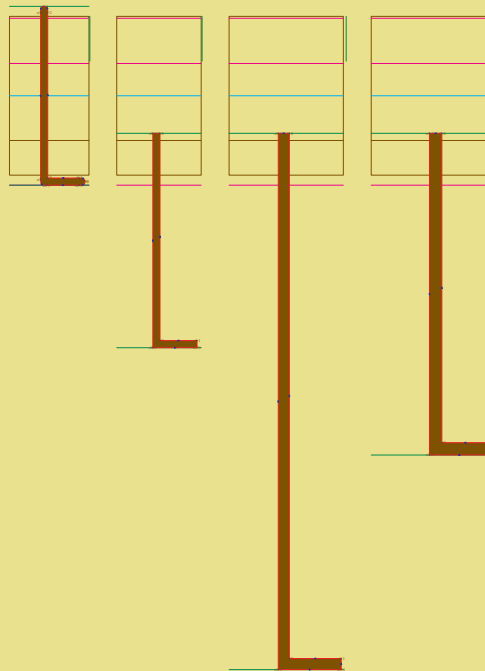

Widths of the ceiling and floor characters is non monotonic: `\Bigg\lfloor` is wider than `\left\lfloor` [high formula].

# Easy?

Like you might expect,  
it's rather hard because of...

# Easy?

Like you might expect,  
it's rather hard because of...  
my favorite Unicode.

“[...] for every character, [...]” – really?



# Unicode problems

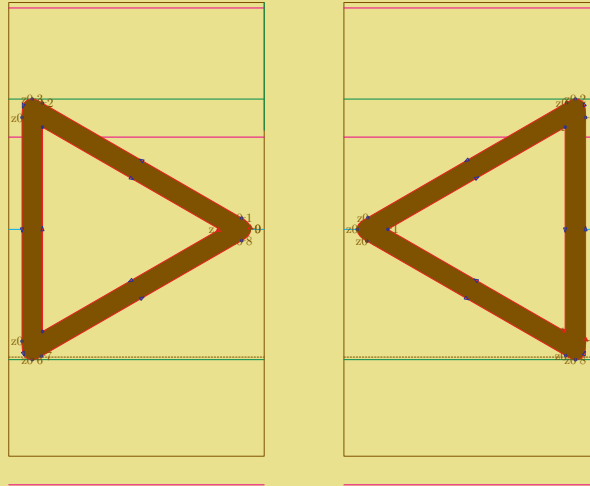

In CMMI we have `\triangleright`,

# Unicode problems

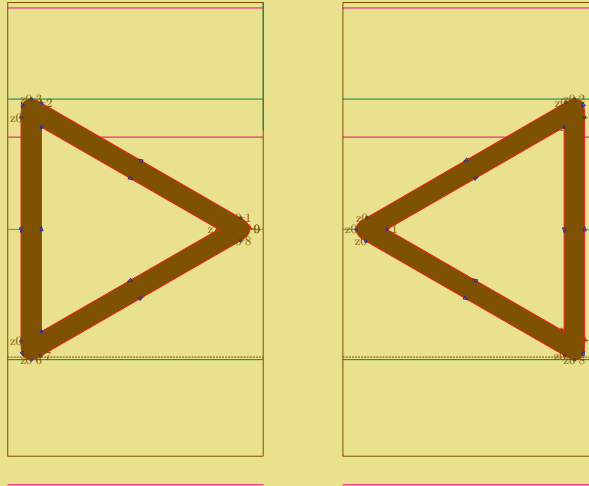

In CMMI we have `\triangleright`,  
in unicode we have:

U+25B7 WHITE RIGHT-POINTING TRIANGLE

U+25B9 WHITE RIGHT-POINTING SMALL TRIANGLE

U+25BB WHITE RIGHT-POINTING POINTER

and analogous set of LEFT TRIANGLES

# Unicode problems

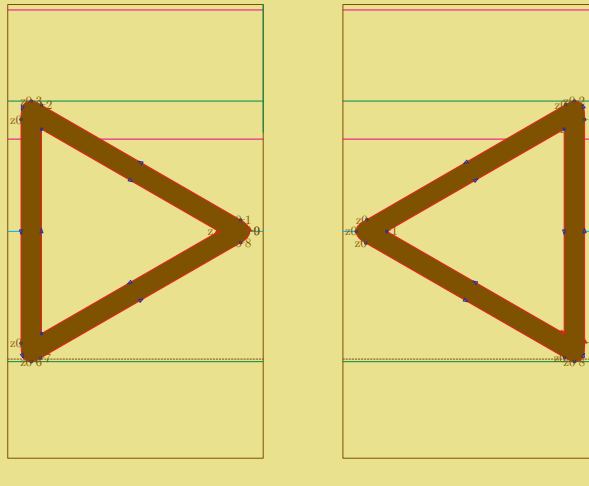

In CMMI we have `\triangleright`,  
in unicode we have:

U+25B7 WHITE RIGHT-POINTING TRIANGLE

U+25B9 WHITE RIGHT-POINTING SMALL TRIANGLE

U+25BB WHITE RIGHT-POINTING POINTER

and analogous set of LEFT TRIANGLES

none of them is like the Knuth's triangle!

# Unicode problems

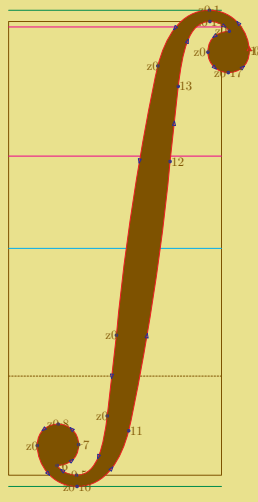

In CMSY we have `\smallintegral`

# Unicode problems

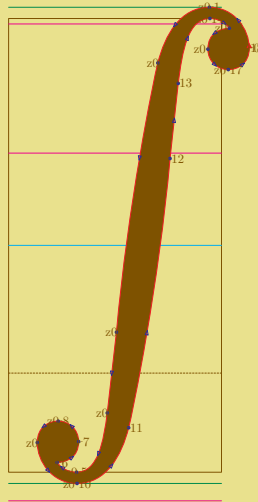

In CMSY we have `\smallintegral`  
but in Unicode there is no place for it

# Unicode problems

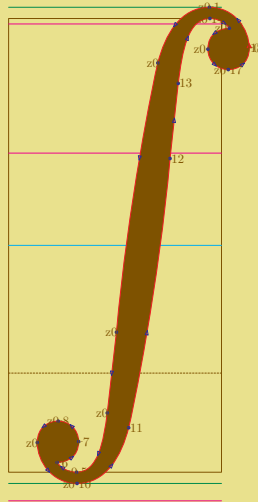

In CMSY we have `\smallintegral`  
but in Unicode there is no place for it  
(may be 0283: LATIN SMALL LETTER ESH  
– we know that is really bad, but...)

# Unicode problems

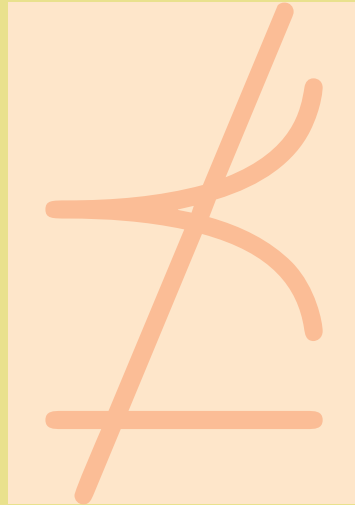

In AMS fonts: `\notpreceq`

# Unicode problems

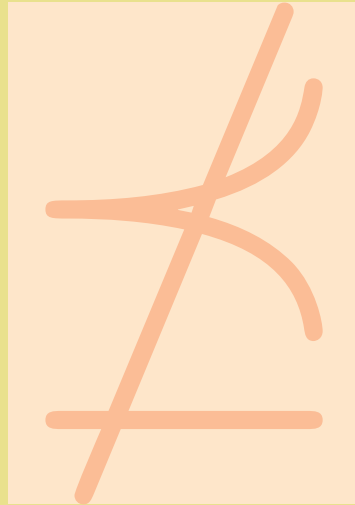

In AMS fonts: `\notpreceq`, but  
in unicode we have:

U+227A PRECEDES

U+2280 DOES NOT PRECEDE

U+227C PRECEDES OR EQUAL TO

U+22E0 DOES NOT PRECEDE OR EQUAL

U+2AAF PRECEDES ABOVE SINGLE-LINE EQUALS SIGN

U+2AB1 PRECEDES ABOVE SINGLE-LINE NOT EQUAL TO



# Easy?

Like you might expect,  
it's rather hard because of...

# Easy?

Like you might expect,  
it's rather hard because of...  
the precision of OTF metrics.

## Easy?

Like you might expect,  
it's rather hard because of...  
the precision of OTF metrics.

In TFM we have 32-bit numbers with  
12-bits on the left side of the decimal point;  
precision is about  $10^{-5}$  pt.

In OTF fonts, width is an integer number  
scaled by font matrix; with the resulting  
precision only  $10^{-2}$  pt.

# Possible?

So achieving exact compatibility  
looks impossible

## Possible?

So achieving exact compatibility  
looks impossible  
so we just abandoned it.

## Possible?

So achieving exact compatibility  
looks impossible  
so we just abandoned it.

We decided to alter (to improve?)  
some Knuth's "decisions".

# Changes

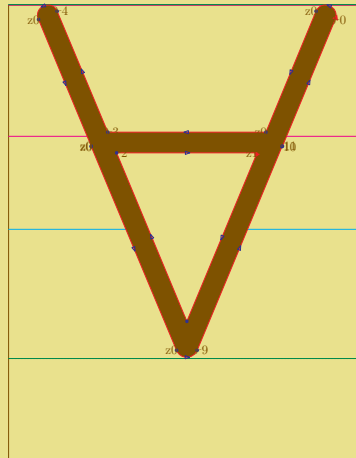

We added sidebearings  
in the `\forall` char.

# Changes

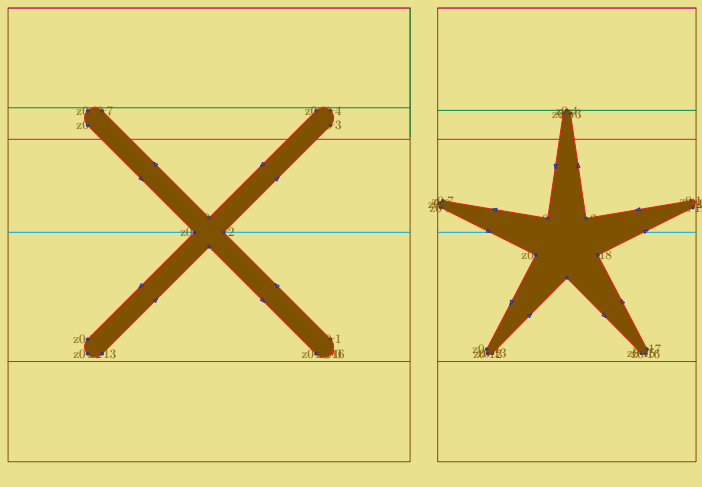

But (for now) we haven't changed the sidebearings of `\times` and `\star`.



## Other changes

We also decided to correct  
some other “features”

(which don't change the metric of the font)

## Other changes

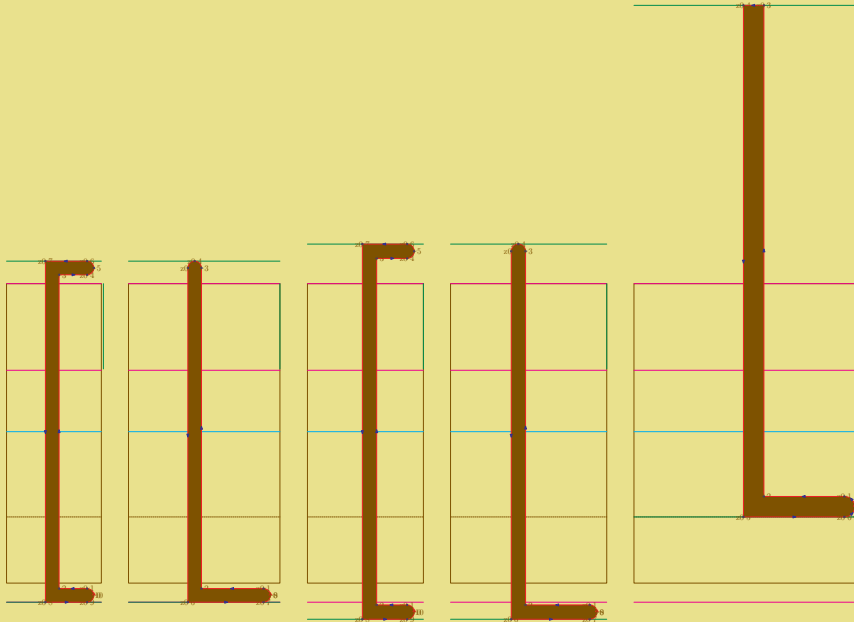

We rounded the ends  
of the  $\lceil$  and  $\lfloor$  characters.

# Other changes

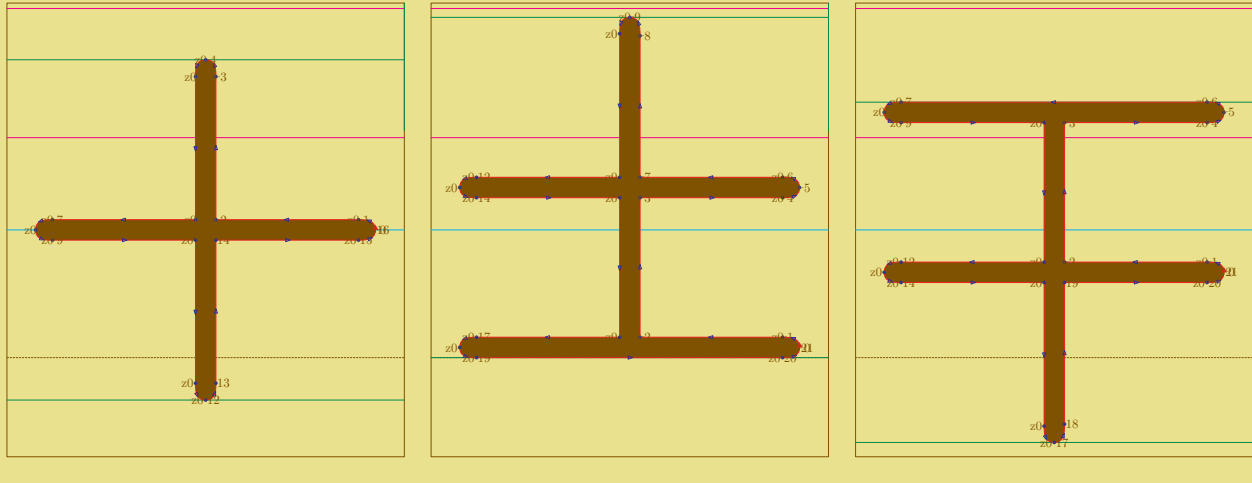

In CM fonts some operators were positioned oddly.

# Other changes

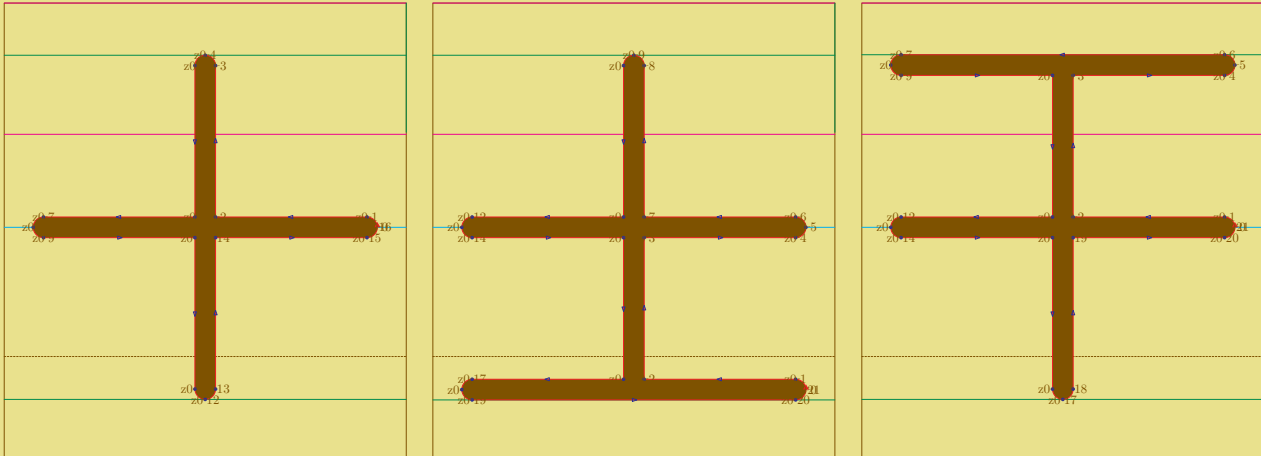

We moderated them a little.

# Yet some more changes

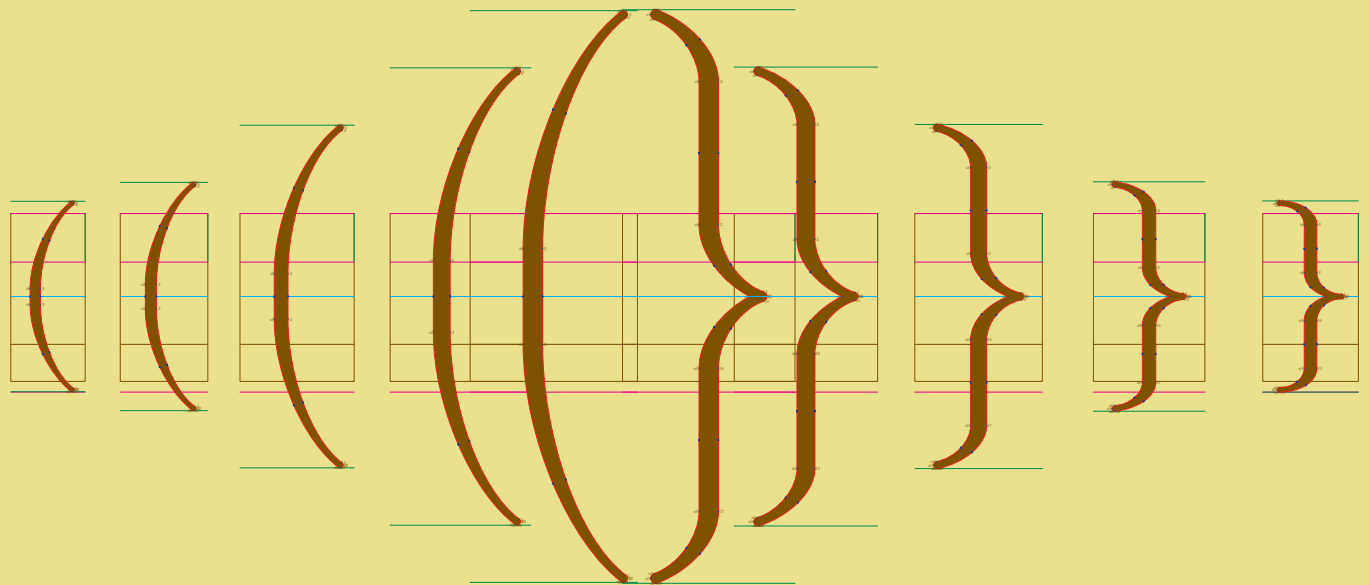

## Yet some more changes

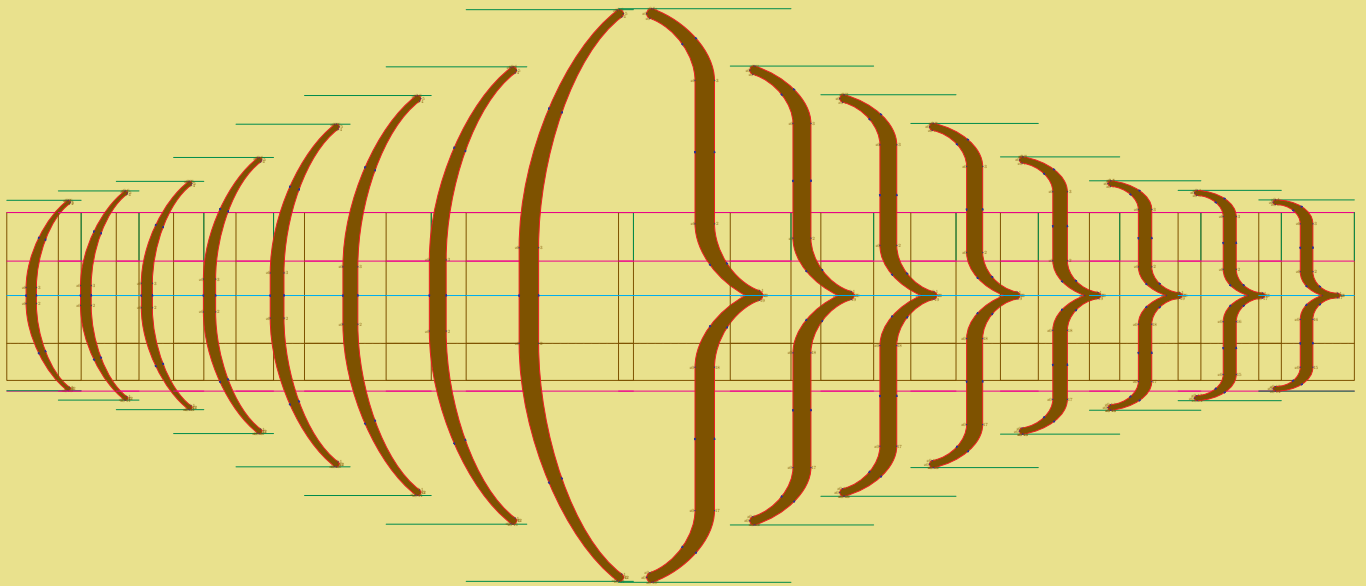

We added more sizes  
for braces and parentheses.

## Yet some more changes

We also decided to remove some `ssty` chains,  
only the variants alphabets have this feature.

# Results

Despite all, we made an effort to keep the widths of Knuthian glyphs.



## Results

Despite all, we made an effort to keep the widths of Knuthian glyphs.

Most of math should typeset being very similar to the originals.

# Dilemmas

There are still many questions...

# Dilemmas

There are still many questions...

- sidebearings of `\times`
- sizes of parenthesis

# Dilemmas

There are still many questions...

- sidebearings of `\times`
- sizes of parenthesis
- scope of the repertoire

# Dilemmas

There are still many questions...

- sidebearings of `\times`
- sizes of parenthesis
- scope of the repertoire
- etc., etc.

# Repertoire

The set of characters is hard to define:

- old Knuth's CM set
- enhanced AMS/L<sup>A</sup>T<sub>E</sub>X set
- our TG Math set
- combination of both above
- extended by some Unicode complement.

The end?

# The end...

is still far away  
but the way is marked out.